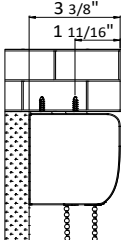
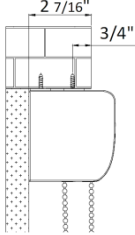
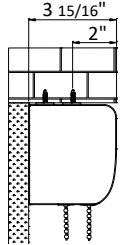
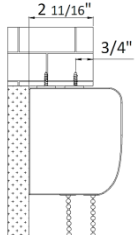
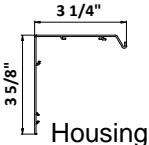
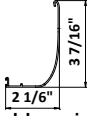
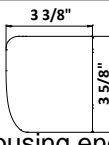
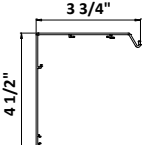
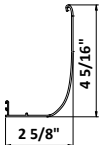
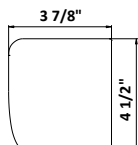

Lift Systems / Applications – Cassette System

Minimum Mounting Depth

3 1/2" Housing & Housing Cover		4 1/2" Housing & Housing Cover	
Flush Inside Mount	Semi-Inside Mount	Flush Inside Mount	Semi-Inside Mount
			

Components

Component	Drawing		
3 1/2" Cassette/Housing			
	Housing	Housing Cover	Housing end cap
4 1/2" Cassette/Housing			
	Housing	Housing Cover	Housing end cap

Fabric Deduction

Single Shade - Inside Mount				
System	Shade Width	Shade Length	Tube Dimensions	Fabric width
Continuous Cord Loop	8" to 60"	12" to 144"	1 1/8"	Fabric Width=Order Width – 1 5/8" (1.60")
	8" to 96"		1 3/4"	Fabric Width=Order Width – 1 5/8" (1.60")
	8" to 118"		2"	Fabric Width=Order Width – 1 5/8" (1.63")
SmartRelease™	12" to 96"	12" to 144"	1 3/4"	Fabric Width=Order Width - 1 3/4" (1.74")
PrecisionLift™ Cordless	9.5" to 96"	12" to 120"	1 3/4"	Fabric Width=Order Width - 1 3/8" (1.38")
	20 1/8" to 118"	12" to 144"	2"	
All other motor	Refer to motorization program guide		1 3/4", 2"	Fabric Width=Order Width - 1 9/16" (1.56")
Norman Smart RB w/ AC Charger				Fabric Width=Order Width - 1 5/8" (1.62")

•For Door Cassette, an additional 1/16" fabric deduction will be taken on each side.

Cassette Deductions

Mounting Type	Finished Width (including end caps)
IM	Cassette width = order width - 1/8"
OM	Cassette width = order width

Mounting Depth Illustrations – Inside Mount

Flush IB-Top mount							
	CCL (with 1 1/8" Clutch)	CCL (with 1 3/4" Clutch)	SmartRelease™ 1 3/4" Clutch	SmartRelease™ 2" Clutch	Cordless/ Motorized with 1 3/4" tube	Cordless/ Motorized with 2" tube	Dual Shades
No Raceway and No Valance	3.27"	3.78"			3.55"	3.79"	4.42" (5.5" bracket)
With a Raceway, but No Valance	3.28"	3.79"	3.51"	3.79"	3.54"	3.79"	5.33" (6.5" bracket)
With a 3.5" Fascia	3.38"	3.58"	3.57"		3.58" (Cordless) 3.57" (Motorized)		
With a 4.5" Fascia	3.94"	4.2"	4.06"	4.19"	4.06"	4.19"	
With Fabric Valance	3.64"(SB) 4.12"(LB)	3.79"(SB) 4.3"(LB)	3.79"(SB) 4.3"(LB)	4.3"	3.79"(SB) 4.3"(LB)		4.98" (5.5" Bracket) 6.12" (6.5" Bracket)
With Wood Crown Valance	4.08"(SB) 4.45"(LB)	4.08"(SB) 4.71"(LB)	4.08"(SB) 4.57"(LB)	4.72"	4.08"(SB) 4.57"(LB)	4.08"(SB) 4.71"(LB)	
With Modern Valance	3.91"(SB) 4.28"(LB)	3.91"(SB) 4.54"(LB)	3.91"(SB) 4.4"(LB)	4.55"	3.91"(SB) 4.4"(LB)	3.91"(SB) 4.54"(LB)	
Basic light guard without raceway	3.19" (1 1/8" tube) 3.5"(1 3/4" tube) 3.58"(2" tube)				3.5"	3.58"	
Basic light guard with raceway	3.33"	3.87"	3.84"	3.87"	3.84"	3.87"	
LightGuard 360™	3.375"(3.5" housing) 3.94"(4.5" housing)						

Semi IB-Top mount							
	CCL (with 1 1/8" Clutch)	CCL (with 1 3/4" Clutch)	SmartRelease™ 1 3/4" Clutch	SmartRelease™ 2" Clutch	Cordless/ Motorized with 1 3/4" tube	Cordless/ Motorized with 2" tube	Dual Shades
No Raceway and No Valance	2.99"	3.25"			3.14"	3.25"	3.63"(5.5" bracket) 4.44"(6.5" bracket)
With a Raceway, but No Valance	2.94"	3.2"	3.05"	3.19"	3.13"	3.25"	
With a 3.5" Fascia	2.68"	2.88"	2.87"		2.87"		
With a 4.5" Fascia	2.94"	3.2"	3.05"	3.19"	3.05"	3.19"	
With Fabric Valance	2.72"(SB) 2.89"(LB)	2.87"(SB) 3.07"(LB)	2.87"(SB) 3.07"(LB)	3.07"	2.87"(SB) 3.07"(LB)		3.55"(5.5" bracket) 4.38"(6.5" bracket)
With Wood Crown Valance	2.88"(SB) 2.94"(LB)	2.88"(SB) 3.2"(LB)	2.87"(SB) 3.05"(LB)	3.19"	2.87"(SB) 3.05"(LB)	2.87"(SB) 3.19"(LB)	
With Modern Valance	2.87"(SB) 3.05"(LB)	2.87"(SB) 3.19"(LB)	2.87"(SB) 3.05"(LB)	3.19"	2.87"(SB) 3.05"(LB)	2.87"(SB) 3.19"(LB)	
Basic light guard without raceway	2.9" (1 1/8" tube) 3.11"(1 3/4" tube) 3.15"(2" tube)				3.1"	3.15"	
Basic light guard with raceway	3"	3.36"	3.36"	3.36"	3.36"	3.36"	

*SB: Small Bracket / LB: Large Bracket

*For 8" fabric valance, the max mounting depth size is 0.2" more than other fabric valances listed above.

Mounting Depth Illustrations – Inside Mount

	IB-Back mount						
	CCL (with 1 1/8" Clutch)	CCL (with 1 3/4" Clutch)	SmartRelease™ 1 3/4" Clutch	SmartRelease™ 2" Clutch	Cordless with 1 3/4" tube	Motorized with 1 3/4" tube	Cordless/ Motorized with 2" tube
With a Raceway, but No Valance	3.38"	3.55	3.55"	3.67	3.46	3.55	3.67
With a 3.5" Fascia	3.48"						
With a 4.5" Fascia	4.09"						
With Fabric Valance	3.7"(SB) 4.3"(LB)						
With Wood Crown Valance	3.99"(SB) 4.6"(LB)						
With Modern Valance	3.82"(SB) 4.43"(LB)						

*SB: Small Bracket / LB: Large Bracket

Mounting Depth Illustrations – Outside Mount

The **mounting area height** refers to the area required for installing screws, and **mounting space height** refers to the space required for the shade

For Single/Coupled Shades

Without Raceway/Valances/Fascias:

Mounting area height: (2 1/16")

Mounting space:

Shade with 1 1/8" tube--mounting space height: (2 3/8")

Shade with 1 3/4" & 2" tube--mounting space height: (2 5/8")

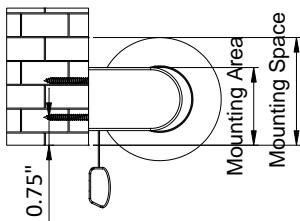

With Raceway/Valances/Fascias:

Minimum mounting space height: 1 1/2"

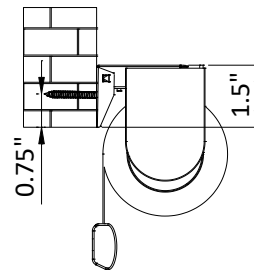

For Dual Shades without/with raceway:

Shade with 5 1/2" bracket--minimum mounting space height: 3 1/16"

Shade with 6 1/2" bracket--minimum mounting space height: 3 13/16"

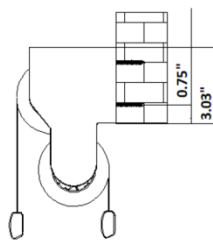

5.5" Bracket

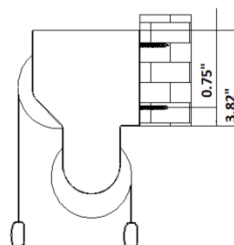

6.5" Bracket

Bracket Dimensions

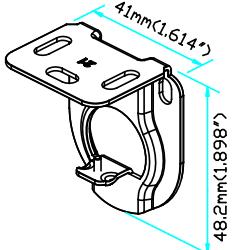
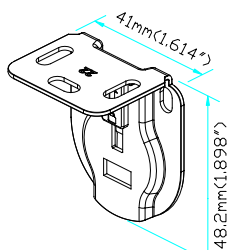
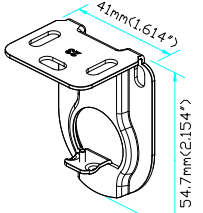
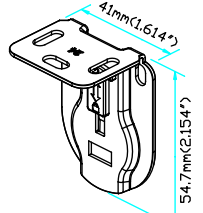
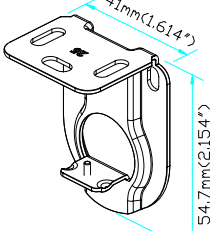
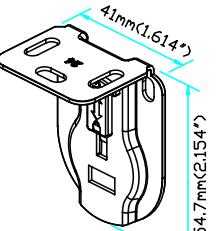
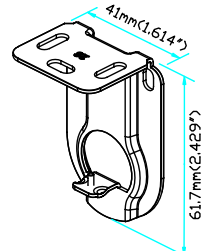
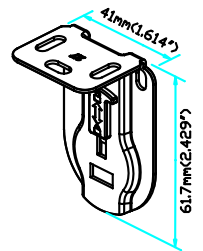
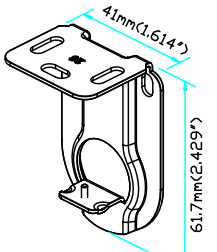
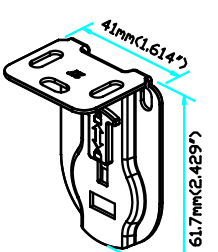
Bracket	Picture		Description
<p>Small Brackets</p>	 <p>41mm(1.614") 48.2mm(1.898")</p> <p>Control Side</p>	 <p>41mm(1.614") 48.2mm(1.898")</p> <p>End Plug Side</p>	<ul style="list-style-type: none"> • 1 1/8" Clutch • Motorized
<p>Medium Brackets</p>	 <p>41mm(1.614") 54.7mm(2.154")</p> <p>Control Side</p>	 <p>41mm(1.614") 54.7mm(2.154")</p> <p>End Plug Side</p>	<ul style="list-style-type: none"> • 1 1/8" Clutch • Motorized
<p>Medium Brackets (with wider lug)</p>	 <p>41mm(1.614") 54.7mm(2.154")</p> <p>Control Side</p>	 <p>41mm(1.614") 54.7mm(2.154")</p> <p>End Plug Side</p>	<ul style="list-style-type: none"> • 1 3/4" Clutch • PrecisionLift™ Cordless
<p>Large Bracket: Motorized</p>	 <p>41mm(1.614") 61.7mm(2.429")</p> <p>Control Side</p>	 <p>41mm(1.614") 61.7mm(2.429")</p> <p>End Plug Side</p>	<ul style="list-style-type: none"> • Motorized • Motorized Coupled (2) / Coupled (3) / Coupled (4)
<p>Large Mounting Brackets (with wider lug)</p>	 <p>41mm(1.614") 61.7mm(2.429")</p> <p>Control Side</p>	 <p>41mm(1.614") 61.7mm(2.429")</p> <p>End Plug Side</p>	<ul style="list-style-type: none"> • 1 3/4" Clutch • PrecisionLift™ Cordless • CCL Coupled (2) / Coupled (3) / Coupled (4)

Bracket Dimensions

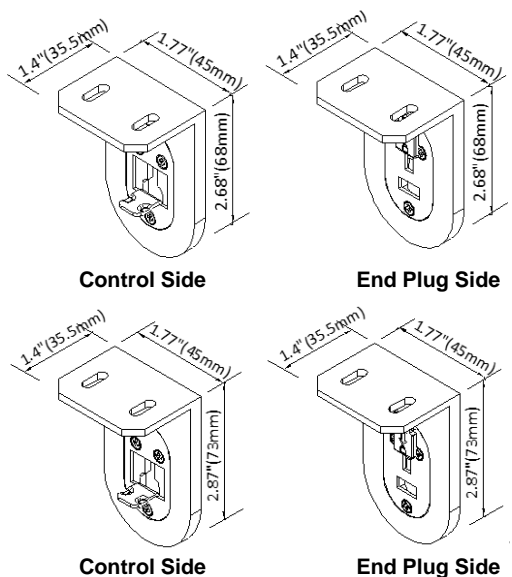
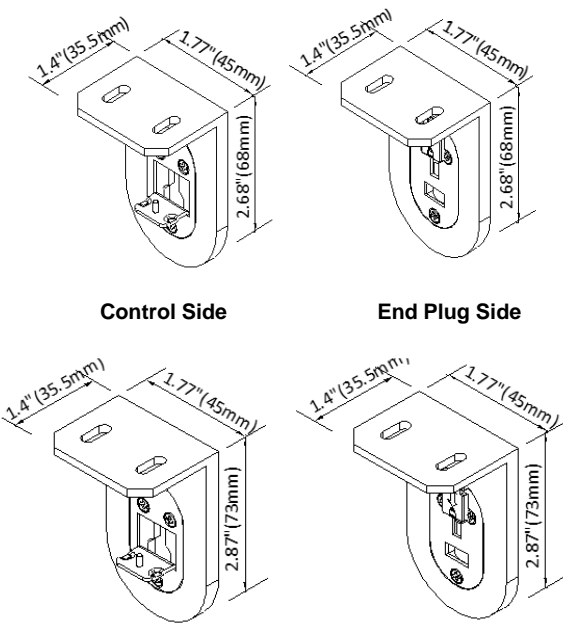
Bracket	Picture	Description
<p>Motorized Brackets</p>	 <p>Control Side End Plug Side</p> <p>Control Side End Plug Side</p>	<ul style="list-style-type: none"> • Premium Hardware • IM/OM without raceway/valances
<p>CordLoop/Cordless Brackets (with wider lug)</p>	 <p>Control Side End Plug Side</p> <p>Control Side End Plug Side</p>	<ul style="list-style-type: none"> • Premium Hardware • IM/OM without raceway/valances

Bracket Dimensions

Inside Mount / Outside Mount Dual Shades

- No Valance " & 8" Fabric Valance

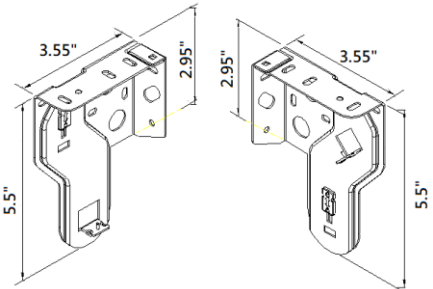
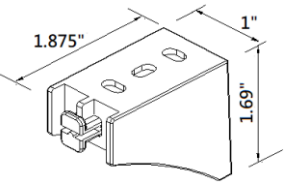
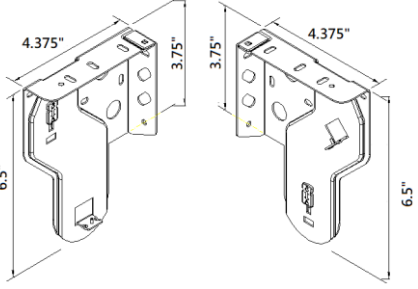
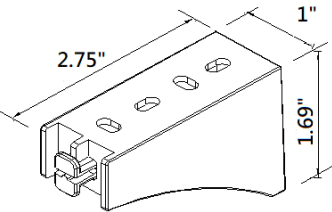
Bracket	Picture	Description
<p>Dual Shades 5.5" Mounting Brackets</p>	 <p>(Left Side) (Right Side)</p>	<p>Used for:</p> <ul style="list-style-type: none"> • IM&OM with/without Raceway
<p>Dual shade 5.5" raceway installation bracket</p>		<p>Used for:</p> <ul style="list-style-type: none"> • IM&OM with Raceway
<p>Dual Shades 6.5" Mounting Brackets</p>	 <p>(Left Side) (Right Side)</p>	<p>Used for:</p> <ul style="list-style-type: none"> • IM&OM with/without Raceway
<p>Dual shade 6.5" raceway installation bracket</p>		<p>Used for:</p> <ul style="list-style-type: none"> • IM&OM with Raceway

Bracket Dimensions

Outside Mount with Raceway

Bracket	Picture	Description
OM mounting bracket-3.5		<p>Used for:</p> <ul style="list-style-type: none"> • Outside mount with raceway • Inside Back mount with raceway
OM mounting bracket-4.5		<p>Used for:</p> <ul style="list-style-type: none"> • Outside mount with raceway • Inside Back mount with raceway

System	Width (X)	Length (Y)	OM Bracket Size
PrecisionLift™ Cordless	X ≤ 96"	Y ≤ 96"	3.5"
		Y > 96"	4.5"
Clutch/Motorized	X ≤ 96"	Y ≤ 96"	3.5"
		Y > 96"	4.5"
	X > 96"	Y ≤ 72"	3.5"
		Y > 72"	4.5"
SmartRelease™	X ≤ 96"	Y ≤ 96"	3.5"
		Y > 96"	4.5"
	X > 96"	All heights	4.5"

This table is for reference only.